



Product Summary

$V_{(BR)DSS}$	$R_{DS(on)TYP}$	I_D
60V	0.9Ω@10V	0.34A
	1.1Ω@4.5V	

Feature

- Trench Technology Power MOSFET
- Low $R_{DS(ON)}$
- Low Gate Charge
- ESD Protected

Application

- Load Switch
- DC/DC Converter

MARKING:

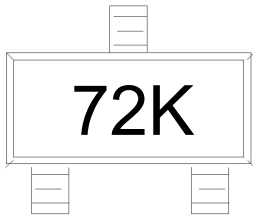

SOT-23

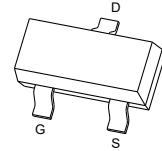

Schematic diagram

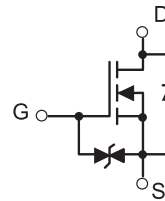

ABSOLUTE MAXIMUM RATINGS ($T_A = 25^\circ\text{C}$ unless otherwise noted)

Parameter	Symbol	Value	Unit
Drain - Source Voltage	V_{DS}	60	V
Gate - Source Voltage	V_{GS}	±20	V
Continuous Drain Current ^{1,5}	I_D	0.34	A
Pulsed Drain Current ²	I_{DM}	1.0	A
Power Dissipation ^{4,5}	P_D	0.35	W
Thermal Resistance from Junction to Ambient ⁵	$R_{\theta JA}$	357	°C/W
Thermal Resistance from Junction to Case	$R_{\theta JC}$	91	°C/W
Operating Junction and Storage Temperature Range	T_J, T_{STG}	-55~ +150	°C

MOSFET ELECTRICAL CHARACTERISTICS (T_A = 25°C unless otherwise noted)

Parameter	Symbol	Test Condition	Min	Type	Max	Unit
Off Characteristics						
Drain - Source Breakdown Voltage	V _{(BR)DSS}	V _{GS} = 0V, I _D = 250μA	60			V
Zero Gate Voltage Drain Current	I _{DSS}	V _{DS} = 48V, V _{GS} = 0V			1	μA
Gate - Body Leakage Current	I _{GSS}	V _{GS} = ±20V, V _{DS} = 0V			±5	μA
On Characteristics³						
Gate Threshold Voltage	V _{GS(th)}	V _{DS} = V _{GS} , I _D = 250μA	1	1.5	2	V
Drain-source On-resistance	R _{DS(on)}	V _{GS} = 10V, I _D = 0.3A		0.9	2.5	Ω
		V _{GS} = 4.5V, I _D = 0.2A		1.1	3	
Dynamic Characteristics						
Input Capacitance	C _{iss}	V _{DS} = 30V, V _{GS} = 0V, f = 1MHz		23.7		pF
Output Capacitance	C _{oss}			5.3		
Reverse Transfer Capacitance	C _{rss}			2.5		
Gate Resistance	R _g	V _{DS} = 0V, V _{GS} = 0V, f = 1MHz		160		Ω
Switching Characteristics						
Total Gate Charge	Q _g	V _{DS} = 30V, V _{GS} = 10V, I _D = 0.3A		0.29		nC
Gate-source Charge	Q _{gs}			0.23		
Gate-drain Charge	Q _{gd}			0.12		
Turn-on Delay Time	t _{d(on)}	V _{DD} = 30V, V _{GS} = 10V, R _L = 100Ω, R _G = 3Ω		3.5		ns
Turn-on Rise Time	t _r			3.2		
Turn-off Delay Time	t _{d(off)}			12		
Turn-off Fall Time	t _f			10		
Source - Drain Diode Characteristics						
Diode Forward Voltage ³	V _{SD}	V _{GS} = 0V, I _S = 0.3A			1.2	V

Notes :

- 1.The maximum current rating is limited by package.
- 2.Pulse Test : Pulse Width ≤ 10μs, duty cycle ≤ 1%.
- 3.Pulse Test : Pulse Width ≤ 300μs, duty cycle ≤ 2%.
- 4.The power dissipation P_D is limited by T_{J(MAX)} = 150°C.
- 5.Device mounted on 1in² FR-4 board with 2oz. Copper, in a still air environment with T_A =25°C.

Typical Characteristics

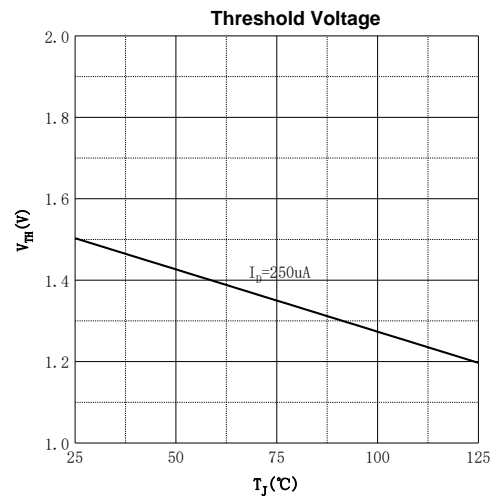
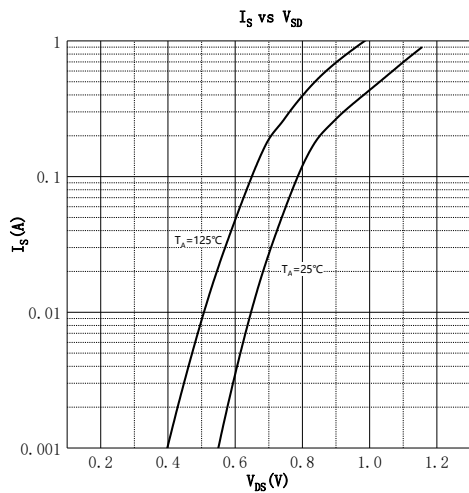
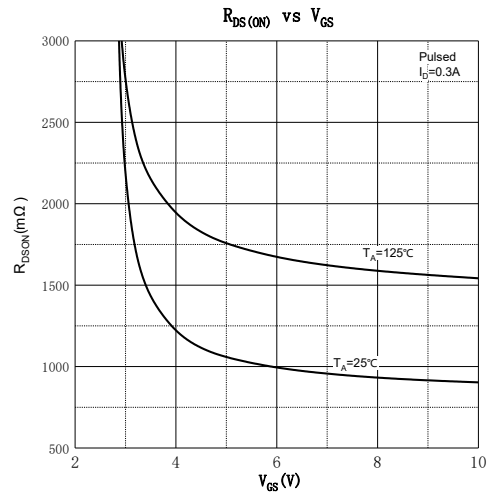
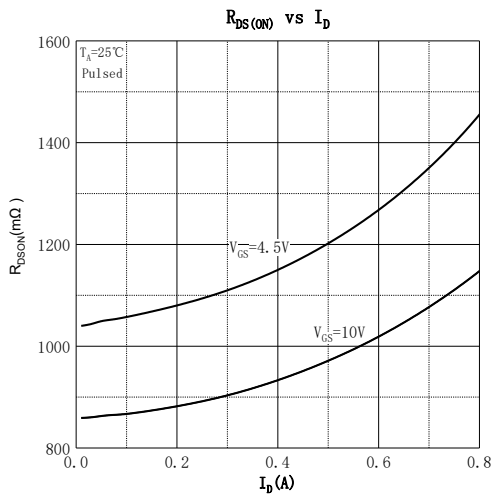
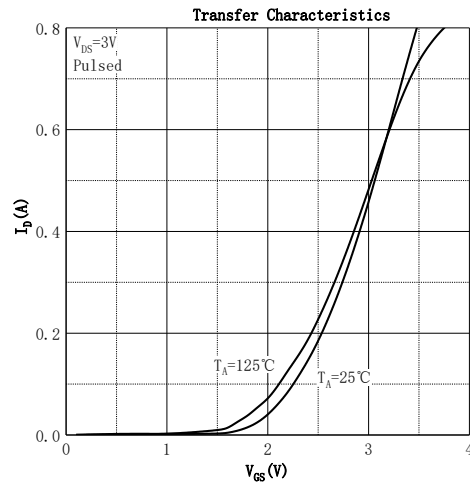
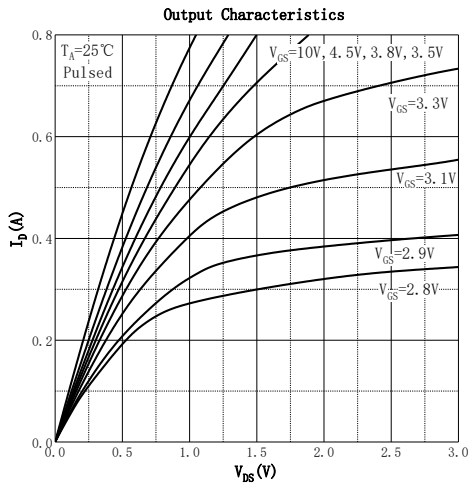

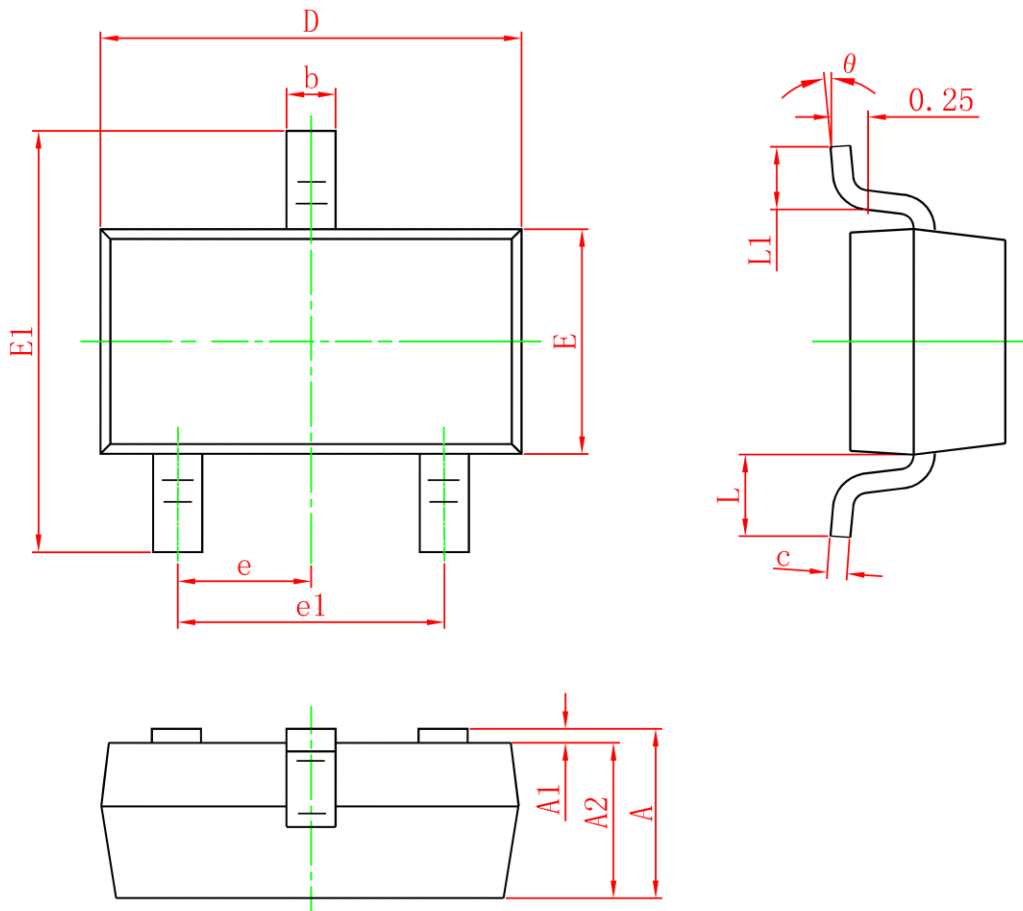
SOT-23 Package Information

Symbol	Dimensions In Millimeters		Dimensions In Inches	
	Min.	Max.	Min.	Max.
A	0.900	1.300	0.035	0.051
A1	0	0.100	0	0.004
A2	0.900	1.200	0.035	0.047
b	0.300	0.550	0.012	0.022
c	0.080	0.158	0.003	0.006
D	2.800	3.000	0.110	0.118
E	1.150	1.500	0.045	0.059
E1	2.200	2.700	0.087	0.106
e	0.950TYP		0.037TYP	
e1	1.800	2.000	0.071	0.079
L	0.550REF		0.022REF	
L1	0.300	0.500	0.012	0.020
θ	0°	8°	0°	8°

Attention:

- GreenPower Electronics reserves the right to improve product design function and reliability without notice.
- Any and all semiconductor products have certain probability to fail or malfunction, which may result in personal injury, death or property damage. Customer are solely responsible for providing adequate safe measures when design their systems.
- GreenPower Electronics products belong to consumer electronics or other civilian electronic products.